

## ATP1006-5 Time switch with holidays

### 1. Function and Scope

ATP1006-3 time switch (hereinafter referred to as “time switch”) is applicable for regularly controlling switch-on and off of street lamps, advertising light boxes and other equipments in automatic control circuit with AC frequency of 50Hz, rated control power voltage of 220V at most and rated working current of 3A at most. This product can control the holidays, users need to manually set the holidays once year.

The product complies with the requirements of Standard GB 14048.5 and IEC 60947-5-1.

### 2 Normal Operating Condition and Installation Condition

2.1 Rated control power voltage: AC (50Hz): 220V.

2.2 Conventional thermal current: 16A.

2.3 Rated working current (Ie): AC-15 220V 3A.

2.4 Timing error:  $\leq 1\text{s/d}$ .

2.5 Holiday can be set: 8 groups.

2.6 Timing settings group: 8 groups(When holidays ignore week mode).

2.7 Time control scope: 1min ~ 168h.

2.8 Electric endurance:  $\geq 10,000$  times.

2.9 Installation method: 35DIN Rail mounting or Screws.

### 3 Outline, Installation Dimension and Wiring Method

3.1 Outside dimension and installation dimension see Figure 1.

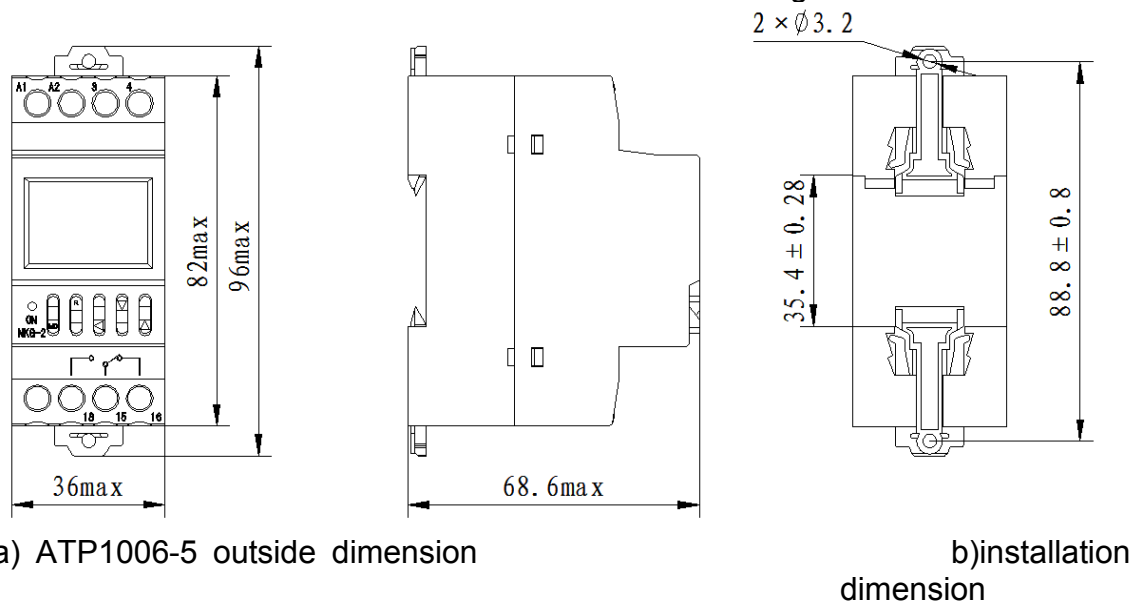

Figure 1 Outside dimensions and installation dimensions of ATP1006-5

### 3.2 Wiring method

#### 3.2.1 Direct control method

Power of the controlled appliance is supplied in single-phase, of which the working current is no more than the rated value of this switch. Direct control method may be adopted, wiring method see Figure 2; for light load with great starting current impact, please adopt AC contactor expansion control method.

#### 3.2.2 Single-phase expansion method

The controlled appliance is power supplied in single-phase, of which the working current exceeds the rated value of this switch. Please adopt AC contactor

E-mail: [fuyang.ke@timer-switch.com](mailto:fuyang.ke@timer-switch.com)

expansion control method, see Figure 3.

### 3.2.3 Three-phase operating method

Power of the controlled appliance is supplied in three-phase, so external AC contactor is required hereof.

- a) The coil voltage of the controlled contactor is AC 220C 50Hz, so its wiring method sees Figure 4;
- b) The coil voltage of the controlled contactor is AC 380V 50Hz, so its wiring method sees Figure 5.

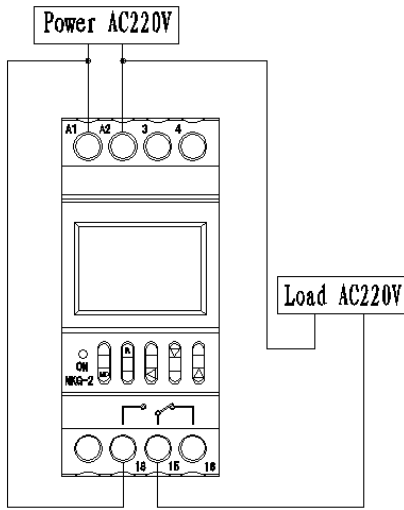

Figure 2 Direct single-phase controlled wiring diagram

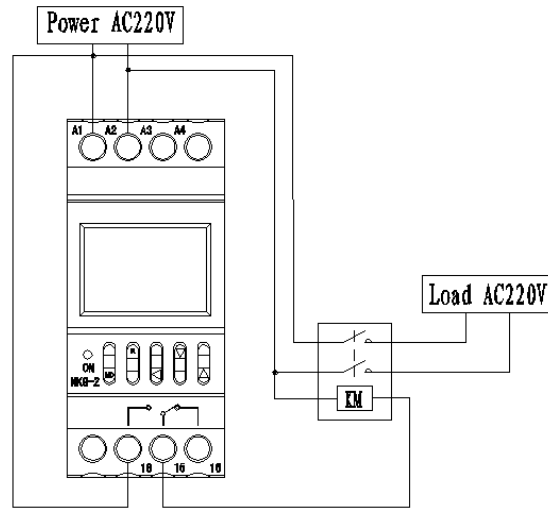

Figure 3 Single-phase expansion controlled wiring diagram

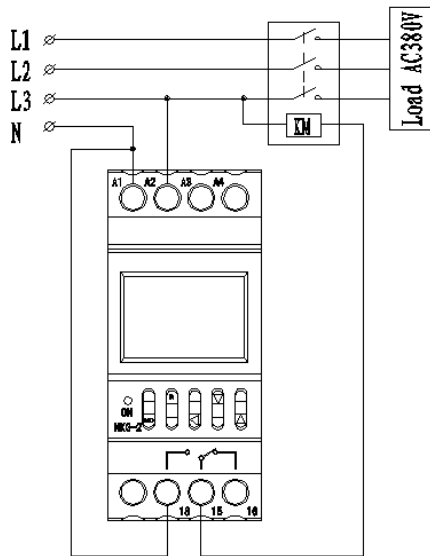

Figure 4 Three-phase controlled wiring diagram (220V for contactor coil)

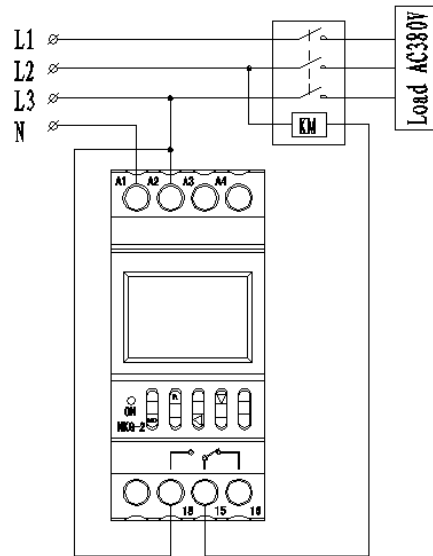

Figure 5

Three-phase controlled wiring diagram (3800V for contactor coil)

## 4 Setting and Use

This product panel is set with five buttons, namely “MD (mode)”, “R (recall)”,

◀ (shift), ▼ (-) and ▲ (+).

4.1 Setting process for Time Switch of Belling apparatus parameters (see Figure 6).

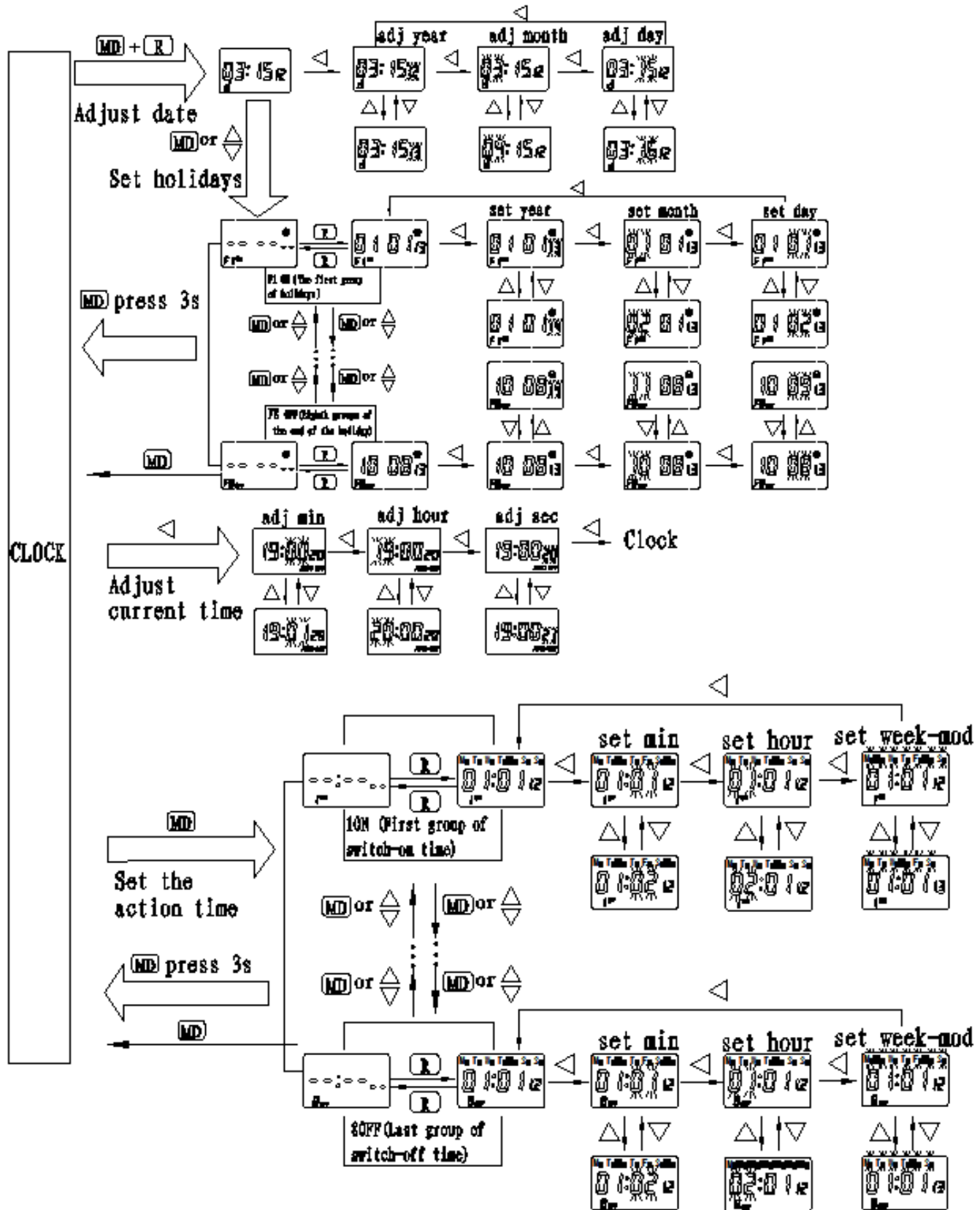

Figure 6 Time switch parameters setting process

4.2 Setting processes are as follows:  
 E-mail: [fuyang.ke@timer-switch.com](mailto:fuyang.ke@timer-switch.com)

4.2.1 Press "MD" + "R" button, enter the current date setting interface.

4.2.1.1 press “◀” to select the adjusted position, press “△” and “▽” to plus and minus, adjust the display date of the product to current date, such as current March 15 shall be set to “03: 15d”, see Figure 7. press "+" and "-" button by long time will automatically key acceleration, After setting, press “MD” to set holidays.

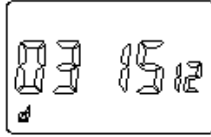

Figure 7

4.2.2 Set holidays

4.2.2.1 Left corner of the screen will display the F1 on, Said the first group of statutory holidays start date, If the date has not been set, then the screen display.”

“ - - - - - ”, as figure 8, Press "R" button to open the group, or press "shift" button to select the adjusted position, For addition and subtraction operation according to the "+" "-", For example, the 2013 New Year's Day holidays start time is in January 1, 2013, set the F1 on date for the "01 01 13", The screen from left to right shows month, day, year, as figure 9, The upper right corner of the screen circular logo represents the holidays.

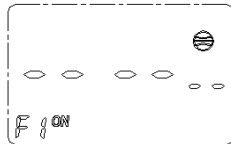

Figure 8

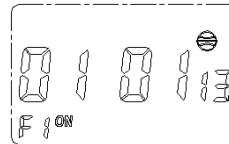

Figure 9

4.2.2.2 The first group of holidays start date after the completion of installation, Press the "MD" button to set the first group holidays end date, The bottom left corner of the screen will display the F1 off, According to the 4.2.2.1 procedure, the date set for January 4, 2013 ( Holiday time is calculated starting from 0 o'clock, so as the new year's holiday time for the end of January 3rd, is required to set the date for the January 4th ) , as figure 10.

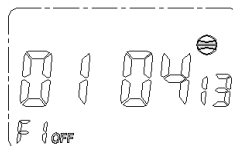

figure 10

4.2.2.3 Continued to press the "MD" key, complete set all the holidays, The holidays can be arranged into 8 groups, Do not need to date, please press the "R" key, the date will be cancelled, as figure 8, Press the "+" and "-" button on the screen without blinking state can leafed through setting parameters.

4.2.2.4 When the date after the completion of installation, press "MD" button in the F8 off location or in any case to press the "MD" button for 3 seconds, the system enters the clock, as shown in figure 11.

4.2.3 The current clock adjustment

4.2.3.1 you can press “◀” to select the adjusted position and press “△” and “▽” to plus and minus, so as to adjust the display time to the current time, see Figure

11.

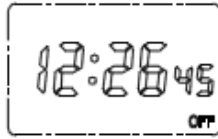

Figure 11

4.2.4 Timing parameters (switch-on/off time) setting

4.2.4.1 press “MD” to set the timing parameters, see Figure 12.

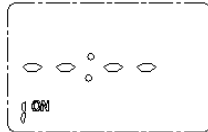

Figure 12

4.2.4.2 1<sub>ON</sub> (first switch-on) time setting: press “◀”, “△” and “▽” respectively to set 1<sub>ON</sub> time, see Figure 13, The top of the screen represents the day will automatically work, Such as the need for Monday to Friday, the screen lit Mo-Fr, if every day the same time requires all lit Mo-Su.

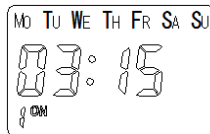

Figure 13

4.2.4.3 Setting 1<sub>OFF</sub> (first switch-off) time: Step 4.2.4.2 1<sub>OFF</sub> set-up time, as shown in figure 14.

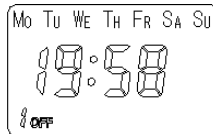

Figure 14

4.2.4.4 Continue to press “MD”, For redundant time period, please press “R” to remove the time of other groups, so that the liquid-crystal display will show“ - - : - - - ”, see Figure 12, and then, press “R” to recall.

4.2.4.5 When setup is complete, press the "MD" key in the 8OFF position, or in the setting process of continuous press "MD" button for 3 seconds, the interface into the clock, as shown in figure 15.



Figure 15

4.3 After locking the switch, press “MD” and “△” at the same time to switch manual/automatic status. Continuously press the combination, the screen will show “OFF”, “AUTO OFF”, “ON” and “ON AUTO” successively, see Figure 14. When the circuit shall be on and off temporarily in the process of operation, the combination buttons can be used to adjust the switch to ON and OFF; if the time switch shall work automatically according to the set time, the combination button shall be used to adjust the switch to “ON AUTO” or “AUTO OFF, then the time switch may work as set time, so as to achieve automatic control, see Figure 14.

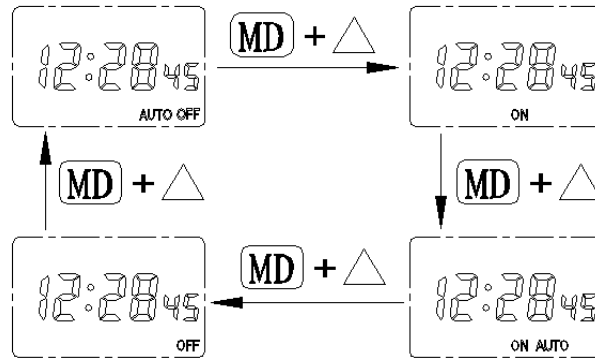

Figure 14 Manual/automatic time switch setting process

### 5 Notes

- 5.1 please push the blue limiting piece In the bottom of product before use.
- 5.2 The switch into the line can only be connected to AC220V power supply, do not access the other power.
- 5.3 If you can not achieve automatic control function, Check the lower right corner of the screen (AUTO) is right shown?
- 5.4 This product in any state standby for 60 seconds will automatically enter the clock.
- 5.5 User note in simulation debugging, only in the time when passing the set point of time, when the control switch will make the appropriate action judgment.
- 5.6 The internal battery can only provide the LCD screen display and settings, such as A1, A2 terminal auxiliary power missed, is unable to drive the relay output..
- 5.7 If the user find errors in the products, Through short 3, 4 terminal reset, After reset procedures need to set again.
- 5.8 The product shelf-life of 18 months, after more than shelf-life after if the product fails, the company still bear the obligation to repair, but the user must bear the corresponding costs.
- 5.9 When the end of the product life, please recycle work product or its components, for not recycled parts, please dispose of, to protect our environment.